

Valve-regulated Stationary Lead-acid Batteries

MSE/HSE Series



Batteries are the energy source that supports the evolution of the advanced information society, as represented by the IT revolution.

"MSE Series" are the most suitable batteries for use in this advanced information society.

"MSE Series" are innovative valve-regulated stationary lead-acid batteries that do not require water refilling throughout their entire lives and have various other features.

Furukawa Battery confidently offers its customers MSE series batteries, which contribute to maintenance-saving and space-saving of the power unit.

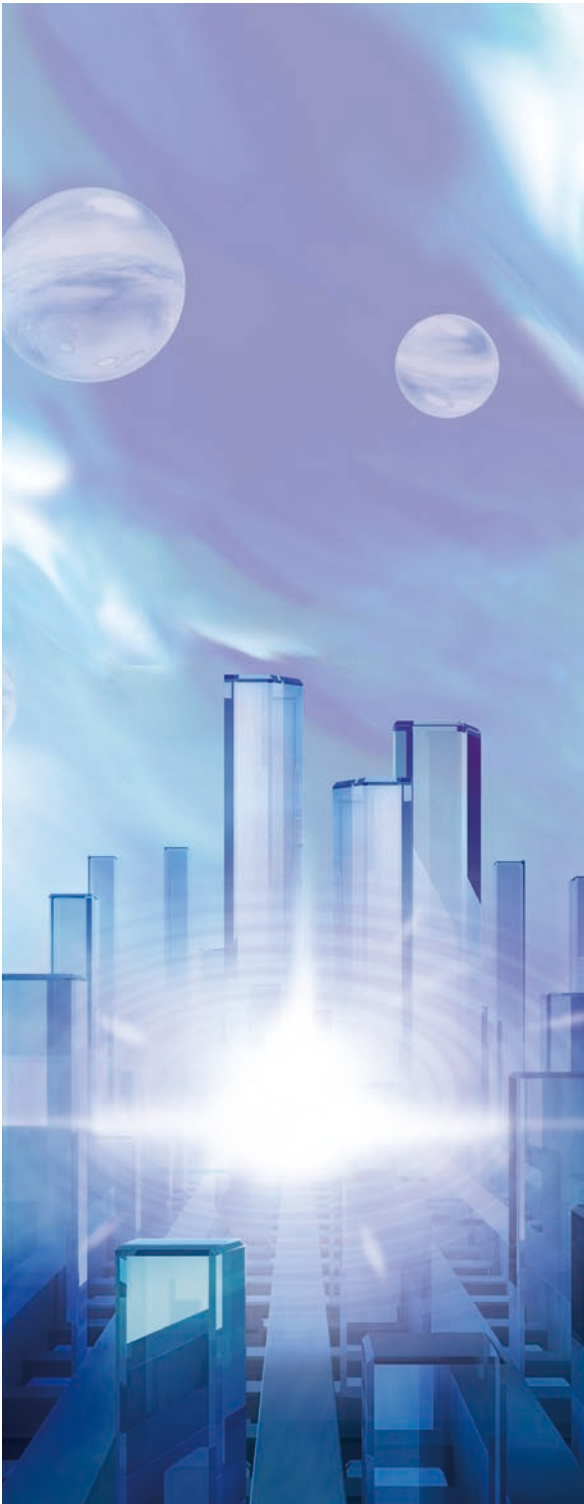

HSE Series



MSE Series



Applications

- UPS
- Communication
- Instrumentation devices
- Emergency lighting systems
- Operation of equipment in power plants and substations
- Disaster and crime prevention systems
- Engine start-up
- And more

Features

● Significantly Reduced Maintenance Work

Oxygen gas generated while charging is absorbed by the negative plate, which has eliminated the need for water refilling under normal use. In addition, the adoption of a special alloy in the electrode plate grid has reduced self-discharge, eliminating the need for equalized charging. These series are easy to use.

● High-performance with High-rate Discharge Characteristics

Special separators with low internal resistance have been adopted with reduced resistance for the conductive parts, providing excellent high-rate discharge characteristics.

● Longer Battery Life with Advanced Battery Plate Technology

The improved battery plate quality and structure provide a longer expected life. HS-E Series batteries have a battery life of 5 to 7 years, but MSE Series batteries have an improved battery life of 7 to 9 years [25°C, 0.1C (A) discharge]. This has reduced the running cost and significantly increased the additional value. (The battery life depends on the service temperature. See the figure to the right.)

● Designed with Safety in Mind

This battery has a closed structure with the electrolyte being absorbed into the plates and separators. In addition, this battery is equipped with an explosion-proof and acid mist-proof filter provided in case there is a recharger failure and the battery is overcharged.

● Advanced Compact Design with Size Reduction by 30%

In addition to the compact body (the volume has been reduced by about 30% from the HS-E Series), HSE/MSE Series batteries do not require space for maintenance such as water refilling and specific gravity measurement, allowing for significant space savings.

● Wide Range of Capacities Available

Batteries are available in a wide range of capacities from 50 Ah to 3,000 Ah. The capacity can be selected to suit the intended application.

Relationship between the temperature and battery life of the HSE and MSE Series

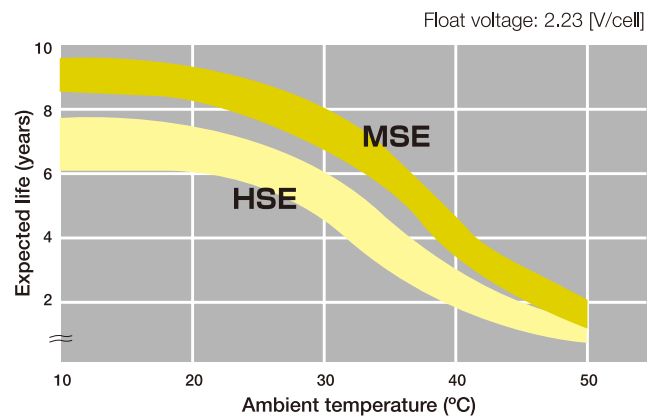

*These values are estimated based on accelerated life testing results, and are not guaranteed values.

Structure

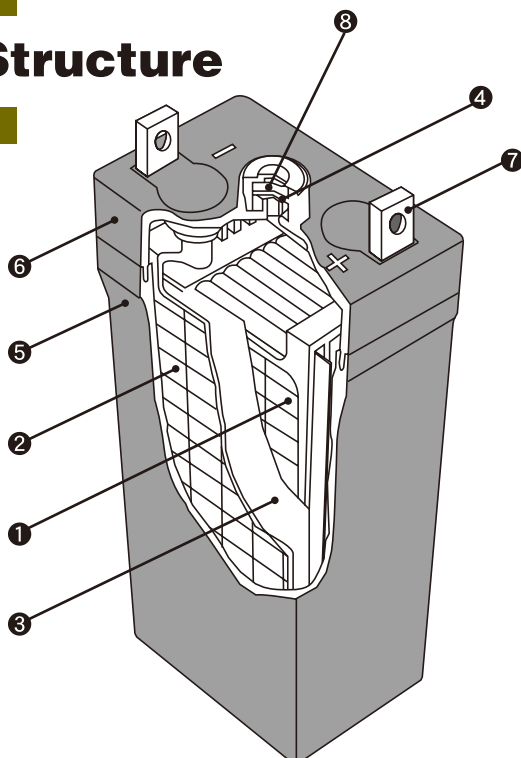

	Part name	Material
①	Positive plate	Lead-calcium alloy/active material
②	Negative plate	Lead-calcium alloy/active material
③	Separator	Non-woven glass fiber
④	Control valve	Synthetic rubber
⑤	Container	ABS resin
⑥	Cell lid	ABS resin
⑦	Terminal	Lead alloy
⑧	Filter	Ceramic

Sealing Principle of Valve-regulated Batteries

Lead-acid batteries, at the end of the charging cycle, decompose water in the electrolyte by electrolysis and generate oxygen gas from the positive plate and hydrogen gas from the negative plate.

To prevent these gases from leaking out of the battery, there is a need to reduce gas generation or absorb the gas in the battery.

Furukawa Battery's valve-regulated stationary lead-acid batteries have the following sealing mechanism:

① The separators are made of a special material with high breathability (non-woven fine glass fiber), and the amount of electrolyte used is limited to a minimum, allowing the gases to pass between the positive and negative plates.

② At the end of the charging cycle, the oxygen gas generated from the positive plate goes through the separators and reaches the negative plate. The oxygen gas then oxidizes sponge lead (Pb), which is a negative active material, to form lead oxide on the negative plate, ceasing to exist as a gas.

Note: In the charged state, the negative active material (Pb) is extremely easily oxidized. In other words, the negative active material easily absorbs the oxygen gas.

③ The oxide lead (PbO) formed on the negative plate reacts immediately with the electrolyte (H₂SO₄) to form lead sulfate (PbSO₄), which is the active material in the discharged state, and water (H₂O). This means that the negative plate is partially discharged when it absorbs oxygen.

④ If charging continues, the lead sulfate (PbSO₄) will be reduced to sponge lead (Pb), but the negative plate will be partially discharged again by the oxygen.

⑤ At the end of the charging cycle, as mentioned above, the negative plate is charged and discharged repeatedly in equilibrium, preventing hydrogen gas from being generated.

⑥ At the same time, the oxygen gas generated from the positive plate is absorbed by the negative plate and ceases to exist as a gas, meaning that for all intents and purposes no water is decomposed by electrolysis. This allows the water content in the electrolyte to be maintained at almost the same level.

⑦ During this time, the internal pressure in the battery increases a little, but the battery container is designed to withstand the pressure increase.

If the battery is charged with a large current and the gas absorption capacity is exceeded, causing the internal pressure to increase, the control valve will operate to relieve the pressure.

⑧ In addition, the control valve prevents the negative plate from being oxidized due to air intrusion and prevents the evaporation of the water.

Sealing Principle of Valve-regulated Batteries

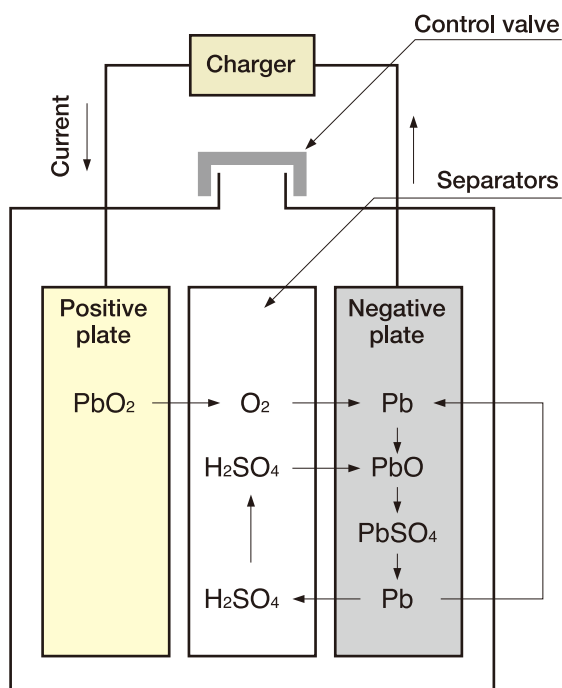

Gas-generating reaction on the positive plate

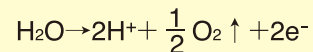

Gas-absorbing reaction on the negative plate

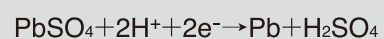
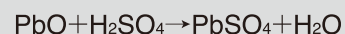
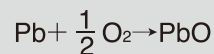

Single-cell Requirements

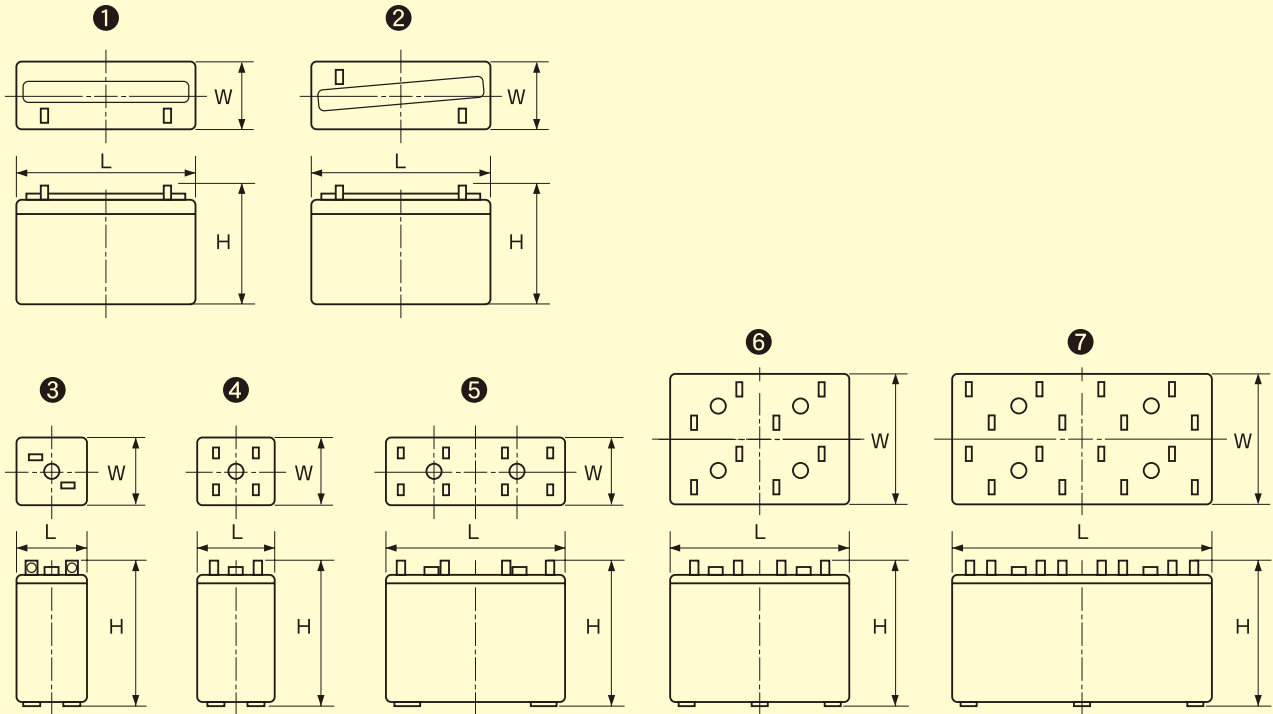

HSE Series

Model	Nominal voltage (V)	Capacity (Ah)		Dimensions (mm)			Mass (approx. kg)	Outline drawing
		10-hour rate	1-hour rate	H (max.)	W (approx.)	L (approx.)		
HSE-30-12	12	30	18	220	128	235	14	①
HSE-40-12	12	40	24	220	128	299	17	①
HSE-50-12	12	50	30	220	128	363	20,5	①
HSE-60-6	6	60	36	220	128	217	13	②
HSE-80-6	6	80	48	220	128	281	17	②
HSE-100-6	6	100	60	220	128	345	20	②

MSE Series

Model	Nominal voltage (V)	Capacity (Ah)		Dimensions (mm)			Mass (approx. kg)	Outline drawing
		10-hour rate	1-hour rate	H (max.)	W (approx.)	L (approx.)		
MSE-50-12	12	50	32.5	220	128	363	20,5	①
MSE-100-6	6	100	65	220	128	345	20	②
MSE-150	2	150	97.5	365	170	106	12	③
MSE-200	2	200	130	365	170	106	15	③
MSE-300	2	300	195	365	170	150	21	③
MSE-500	2	500	325	365	171	241	35	④
MSE-1000	2	1000	650	365	171	471	70	⑤
MSE-1500	2	1500	975	375	337	476	108	⑥
MSE-2000	2	2000	1300	375	337	476	139	⑥
MSE-3000	2	3000	1950	375	340	696	209	⑦

Required capacity (Ah/10 hr)	Combinations
50	MSE-50-12
100	MSE-100-6
150	MSE-150
200	MSE-200
300	MSE-300
400	MSE-200×2
500	MSE-500
600	MSE-300×2
700	MSE-200+MSE-500
800	MSE-300+MSE-500
900	MSE-300×3
1000	MSE-1000
1100	MSE-300×2+MSE-500
1200	MSE-200+MSE-500×2
1300	MSE-300+MSE-500×2
1500	MSE-1500
2000	MSE-2000
2500	MSE-1000+MSE-1500
3000	MSE-3000

Battery Rack Requirements

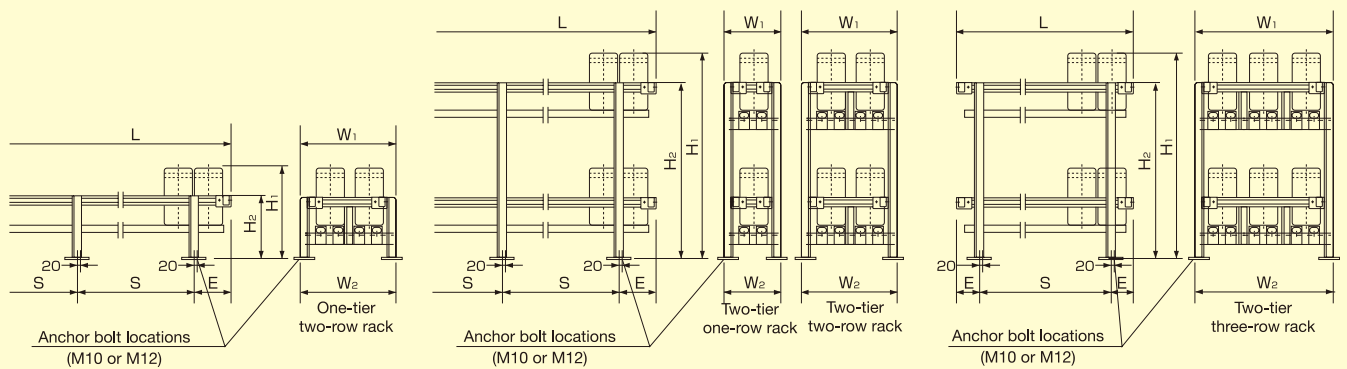

Battery model	One-tier rack				Two-tier rack										Three-tier rack					
	H ₁	H ₂	Two rows		H ₁	H ₂	One row		Two rows		Three rows		Four rows		H ₁	H ₂	Two rows		Four rows	
			W ₁	W ₂			W ₁	W ₂	W ₁	W ₂	W ₁	W ₂	W ₁	W ₂			W ₁	W ₂		
MSE-150 MSE-200	528	343	552	552	1216	1031	316	316	552	552	808	798	1044	1034	1749	1564	572	562	1044	1034
MSE-300	528	343	552	552	1216	1031	316	316	552	552	808	798	1044	1034	1749	1564	572	562	1044	1034
MSE-500	543	358	694	694	1246	1061	407	397	714	704	1021	1011	1328	1318	1794	1609	714	704	1328	1318
MSE-1000	543	358	1174	1164	1246	1061	637	627	1174	1164	—	—	—	—	1794	1609	1269	1244	—	—
MSE-1500	553	368	1184	1174	1266	1081	672	647	1279	1254	—	—	—	—	1824	1639	1279	1254	—	—
MSE-2000	553	368	1184	1174	1266	1081	672	647	1279	1254	—	—	—	—	1824	1639	1279	1254	—	—
MSE-3000	553	368	1624	1614	1266	1081	892	867	1723	1694	—	—	—	—	1824	1639	1749	1714	—	—

- Notes 1) For battery racks indicated with a Δ, dimension E is 150.
 2) Other racks shapes are available.
 3) All dimensions are given in millimeters.
 4) The anchor bolt locations are given as reference values.

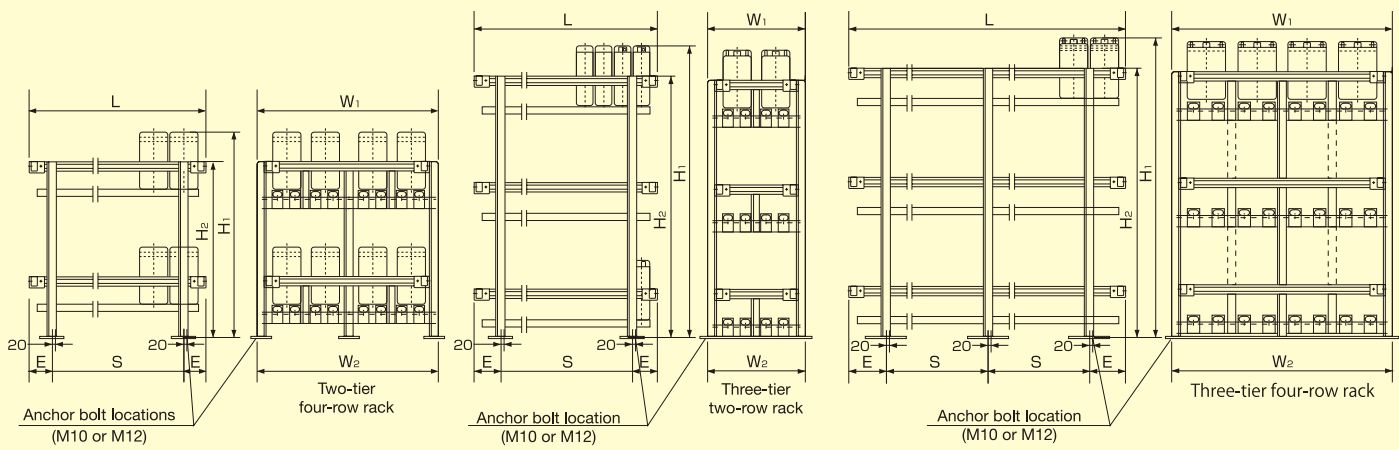

Number of cells per row												E
5	6	7	8	9	10	11	12	13	14	15	16	
L S xn	L S xn	L S xn	L S xn	L S xn	L S xn	L S xn	L S xn	L S xn	L S xn	L S xn	L S xn	
△630 330 x1	△741 441 x1	△852 552 x1	△963 663 x1	△1074 774 x1	1185 755 x1	1296 866 x1	1407 977 x1	1518 544 x2	1629 599.5 x2	1740 655 x2	1851 710.5 x2	215 △150
△850 550 x1	△1005 705 x1	1160 730 x1	1315 885 x1	1470 520 x2	1625 597.5 x2	1780 675 x2	1935 752.5 x2	2090 830 x2	2245 907.5 x2	2400 656.7 x3	2555 708.3 x3	215 △150
950 520 x1	1125 695 x1	1300 870 x1	1475 522.5 x2	1650 610 x2	1825 697.5 x2	2000 785 x2	2175 872.5 x2	2350 640 x3	2525 698.3 x3	2700 756.6 x3	2875 815 x3	215
950 520 x1	1125 695 x1	1300 870 x1	1475 522.5 x2	1650 610 x2	1825 697.5 x2	2000 785 x2	2175 872.5 x2	2350 640 x3	2525 698.3 x3	2700 756.6 x3	2875 815 x3	215
1785 677.5 x2	2127 848.5 x2	2469 679.7 x3	2811 793.7 x3	3153 907.7 x3	3495 766.3 x4	3837 851.8 x4	4179 749.8 x5	4521 818.2 x5	4863 886.6 x5	5205 795.8 x6	5547 852.8 x6	215
1785 677.5 x2	2127 848.5 x2	2469 679.7 x3	2811 793.7 x3	3153 907.7 x3	3495 766.3 x4	3837 851.8 x4	4179 749.8 x5	4521 818.2 x5	4863 886.6 x5	5205 795.8 x6	5547 852.8 x6	215
1800 685 x2	2145 857.5 x2	2490 686.7 x3	2835 801.7 x3	3180 916.7 x3	3525 773.8 x4	3870 860 x4	4215 757 x5	4560 826 x5	4905 895 x5	5250 803.3 x6	5595 860.8 x6	215

Knock-down type Material: mild steel
 Standard color: Munsell No. 5Y7/1, semi-gloss Acid-resistant coating Seismic resistance: Static horizontal acceleration 1 G

Characteristics

MSE Series Discharge Current-Capacity Characteristics

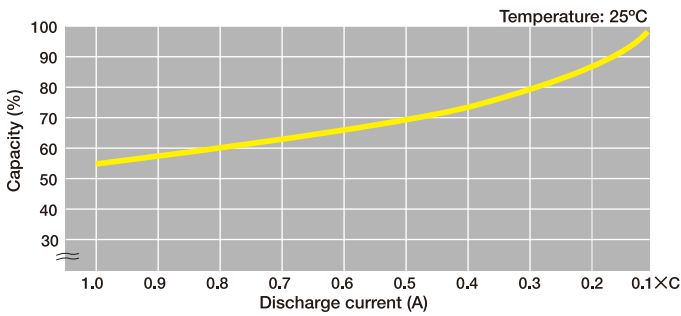

HSE Series Discharge Current-Capacity Characteristics

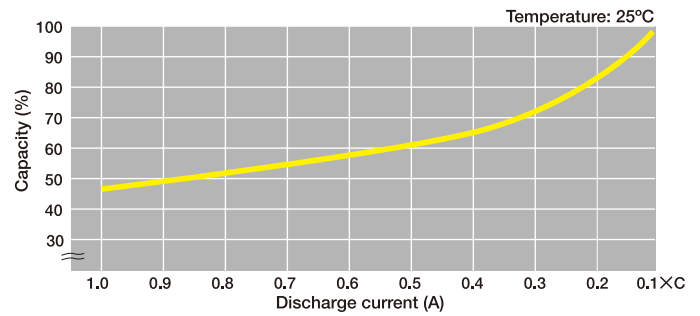

MSE Series Temperature-Capacity Characteristics

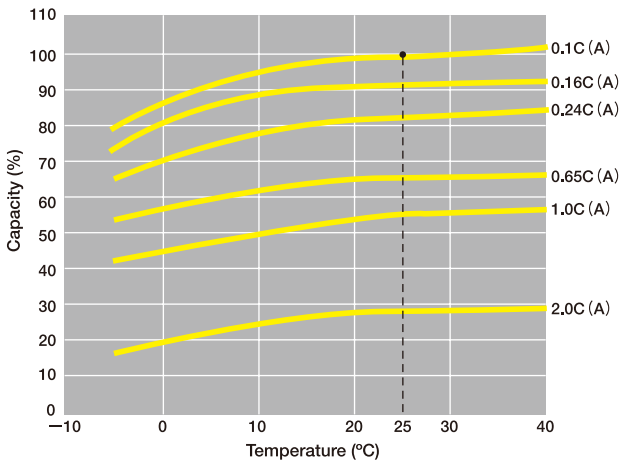

HSE Series Temperature-Capacity Characteristics

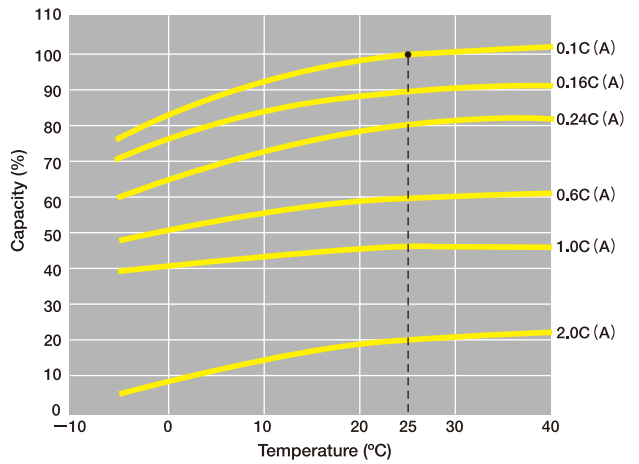

MSE Series Discharge Characteristics with Varying Discharge Rate

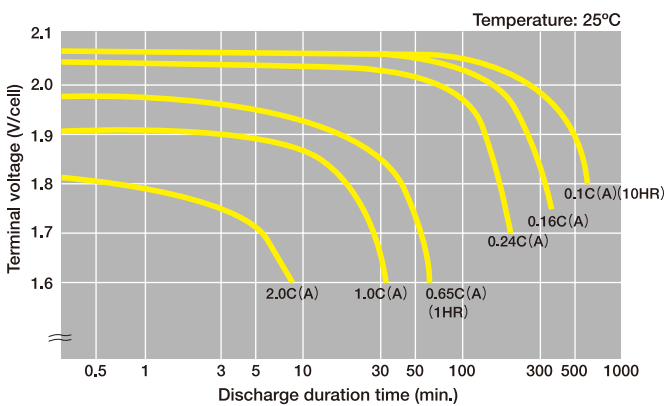

HSE Series Discharge Characteristics with Varying Discharge Rate

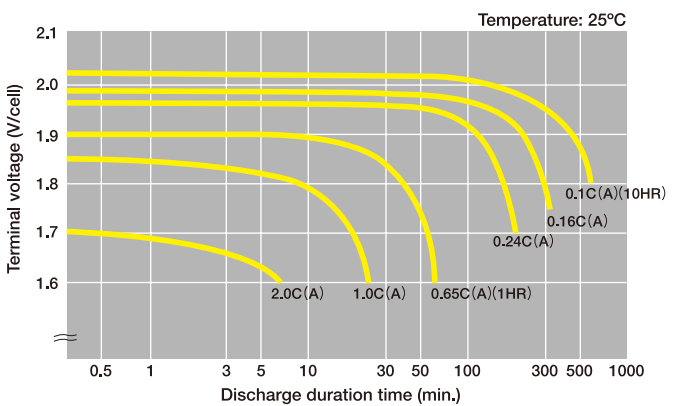

**C" indicates the value of the rated capacity at a 10-hour rate.

Comparison between Valve-regulated and Catalytic Plug Batteries

		Valve-regulated batteries	Catalytic plug batteries
Maintenance-saving (principle)		At the end of the charging cycle, the oxygen gas generated from the positive plate is absorbed by the negative plate, ceasing to exist as a gas. At the same time, the negative plate is kept in a discharged state, by means of a chemical reaction, so as to prevent hydrogen gas from being generated.	At the end of the charging cycle, the water in the electrolyte is decomposed by electrolysis to form oxygen and hydrogen gases. These gases are guided to the catalytic plug and recombined by catalysis to form water, which is circulated in the cell.
Maintenance-saving (structure)		Using special separators and keeping the amount of electrolyte used to a minimum allows the gases to pass between the positive and negative plates, enabling the negative plate to absorb the gases more efficiently.	A catalytic plug is installed onto the vent of a vented battery (CS, HS).
Plate types		Paste type (HSE) Paste type (MSE) Lead-calcium alloy	Clad type (CS-E) Paste type (HS-E) Lead-antimony alloy
Capacity range		Paste type HSE 12V: 30Ah~50Ah 6V: 60Ah~100Ah Paste type MSE 12V: 50Ah 6V: 100Ah 2V: 150Ah~3000Ah	Clad type 2V: 15Ah~2400Ah 6V: 15Ah~90Ah Paste type 2V: 30Ah~2500Ah 6V: 30Ah~120Ah
Characteristics	High-rate discharge characteristics	HSE Series: Excellent MSE Series: Extremely excellent	Clad type: Normal Paste type: Excellent
	Self-discharge rate	0.1% or less per day	0.5% or less per day
	Expected life (25°C)	HSE Series: about 5 to 7 years MSE Series: about 7 to 9 years	Clad type: 10 to 14 years Paste type: 5 to 7 years
Maintenance	Float voltage	2.23 V per cell (Constant voltage available)	Clad type: 2.15 V per cell Paste type: 2.18 V per cell
	Equalizing charge frequency	Not required	Once every 3 to 6 months
	Water refilling frequency	Not required	Once every 3 to 5 years
	Specific gravity measurement	Not required	Once a month
	Electrolyte level check	Not required	Required (The electrolyte level decreases slightly.)
	Parts replacement	Not required	Catalytic plug: Requires replacement every 3 to 5 years.
Volume ratio		60~70	100
Installation area ratio		60~70	100



Precautions for Safe Use

- To use the battery safely and properly, be sure to read the instruction manual before use.

Danger

- For stationary batteries, ensure that the room is well ventilated so that the hydrogen concentration is 0.8% or less. Failure to do so may cause fire or explosion.
- Do not install the battery in a poorly-ventilated area where the hydrogen concentration becomes more than 0.8%, or near open flame. Doing so may cause fire or explosion.

Caution

- The service temperature range of the battery is from -15 to 45°C. Using the battery outside this range may accelerate deterioration or cause the battery to freeze or overheat, resulting in damage or deformation.
- Do not use this battery where it is exposed to direct sunlight. Doing so may cause the parts of the battery to deteriorate.
- Do not expose the battery to water or seawater. Doing so may cause damage to the battery or fire, or cause the terminals or connecting plates to corrode.
- Do not use the battery near a heat source. Doing so may cause damage to the battery or cause the battery life to shorten.
- Do not use the battery in dusty areas. Doing so may cause a short-circuit.
- Charge the battery under the charging conditions recommended by Furukawa Battery. Failure to do so may result in insufficient charging, electrolyte leakage, temperature rise, explosion, deterioration in performance, or reduced service life.
- Install the battery horizontally with the terminals facing up and ensure that the battery is not tilted more than 90°. Failure to do so may cause electrolyte leakage.
- Ensure that the maximum discharge current is not exceeded for more than 1 minute for 3C (A) or for more than 5 seconds for 6C (A). Failure to do so may cause damage to the battery.
- Periodically inspect the battery. If the results deviate from the standards specified in the instruction manual, follow the steps in the instruction manual. Using the battery with such deviations may cause damage to the battery, or burnout.



ISO9001 Certified
JQA-1118
(THE FURUKAWA BATTERY CO., LTD.)



ISO14001 Certified
JQA-EM0380
(Iwaki and Imaichi Plants)

*Actual colors may differ slightly from those in the photo due to printing limitations.

- Contact Information

FB THE FURUKAWA BATTERY CO., LTD.

2-4-1 Hoshikawa, Hodogaya-ku, Yokohama, Kanagawa Prefecture 240-0006 Japan

<http://www.furukawadenchi.co.jp>

- Information contained in this catalogue is current as of August 2010 and may be subject to change without notice. For detailed information, please contact the Industrial Equipment Sales Department.